

XUM4ANXBM8

Photoelectric sensors XU, miniature, diffuse short, Smax=0.25 m, NPN, connector M8



Main

Range of product	Telemecanique Photoelectric sensors XU
Series name	General purpose single mode
Electronic sensor type	Photo-electric sensor
Sensor name	XUM
Sensor design	Miniature
Detection system	Diffuse
Material	Plastic
Type of output signal	Discrete
Supply circuit type	DC
Wiring technique	3-wire
Discrete output type	NPN
Discrete output function	1 NO or 1 NC programmable
Electrical connection	Male connector M8, 4 pins
Emission	Infrared diffuse
[Sn] nominal sensing distance	0.17 m

Complementary

Enclosure material	PBT
Lens material	PMMA
Maximum sensing distance	0.25 m
Output type	Solid state
Status LED	Stability: 1 LED (green) Output state: 1 LED (orange)
[Us] rated supply voltage	12...24 V DC with reverse polarity protection
Supply voltage limits	10...30 V DC
Switching capacity in mA	<= 100 mA with overload and short-circuit protection
Switching frequency	<= 1000 Hz
Maximum voltage drop	<2 V
Current consumption	20 mA no-load
Maximum delay first up	100 ms
Maximum delay response	0.5 ms
Maximum delay recovery	0.5 ms
Setting-up	Sensitivity by potentiometer
Depth	20 mm
Height	44 mm
Width	10 mm
Product weight	0.01 kg

Environment

Product certifications	CULus CE UKCA
Ambient air temperature for operation	-30...55 °C
Ambient air temperature for storage	-40...70 °C
Relative humidity	35...95 %
Immunity to ambient light	40000 Lux sunlight 10000 lux incandescent light

Vibration resistance	9 gn, amplitude = +/- 1.5 mm (f = 10...500 Hz) for every axis conforming to IEC 60068-2-6
Shock resistance	100 gn (duration = 11 ms) for every axis conforming to IEC 60068-2-27
IP degree of protection	IP67 conforming to IEC 60529 IP65 conforming to IEC 60529

Packing Units

Unit Type of Package 1	PCE
Number of Units in Package 1	1
Package 1 Height	1.5 cm
Package 1 Width	4.5 cm
Package 1 Length	9.0 cm
Package 1 Weight	14.0 g
Unit Type of Package 2	S02
Number of Units in Package 2	120
Package 2 Height	15.0 cm
Package 2 Width	30.0 cm
Package 2 Length	40.0 cm
Package 2 Weight	2.062 kg

Offer Sustainability

REACH Regulation	REACH Declaration
EU RoHS Directive	Pro-active compliance (Product out of EU RoHS legal scope) EU RoHS Declaration
Mercury free	Yes
China RoHS Regulation	China RoHS declaration
RoHS exemption information	Yes
California proposition 65	WARNING: This product can expose you to chemicals including: Diisononyl phthalate (DINP), which is known to the State of California to cause cancer, and Di-isodecyl phthalate (DIDP), which is known to the State of California to cause birth defects or other reproductive harm. For more information go to www.P65Warnings.ca.gov

Contractual warranty

Warranty	18 months
----------	-----------

Dimensions

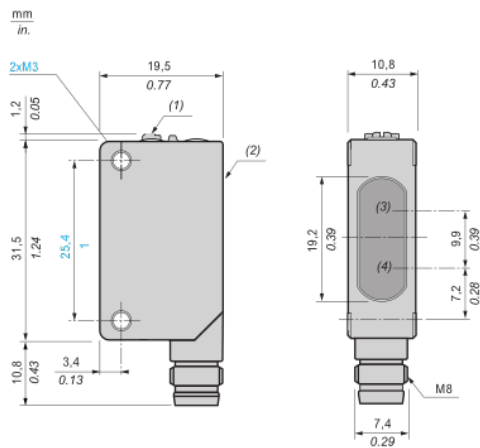

- (1) : Setting potentiometer (sensitivity)
- (2) : Setting potentiometer (output)
- (3) : Reception
- (4) : Transmission

Connection and schema

Wiring diagram

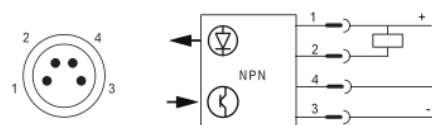

1 : (+)

2 : Not connected

3 : (-)

4 : OUT/Output

Detection curves

Object size/sensing distance

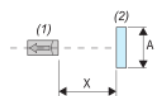
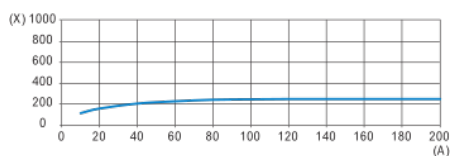

- (1) : Sensor
- (2) : Object (white mat paper of A mm square)
- (A) : Side length (mm)
- (X) : Sensing distance (mm)

Lateral displacement

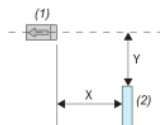
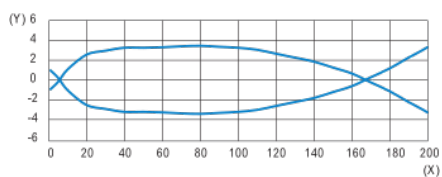

- (1) : Sensor
- (2) : Object (200 x 200 mm square white paper)
- (X) : Sensing distance (mm)
- (Y) : Lateral displacement (mm)

Excess gain

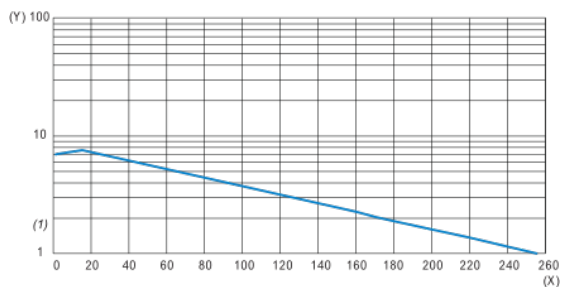

- (1) : Operation level
- (X) : Sensing distance (m)
- (Y) : Excess gain